



QUALITY REDEFINED®

Design is so much more than just the appearance alone. It's the way something functions on so many particular levels. Ultimately of course, quality defines so much of our user experience, leaving us with only one question. How are quality cabinets truly defined? In an industry where quality is the most essential factor, we've considered this matter time and time again. After performing a thorough analysis alongside industry professionals, the definition of quality cabinets has been narrowed down to twelve unique attributes.

Collectively, these twelve simple but significant pillars have been given an even simpler name - Quality 12.

To be sure quality is applied across the entire construction, we've considered every single detail from the ground up, allowing for uniformity and compatibility between all individual elements.

A Q12 cabinet encompasses 12 facets that together make up a superior product.



QUALITY SOURCED LUMBER

This Q12 standard requires the use of carefully selected top-grade lumber, guaranteeing the finest and most dependable kitchen cabinets. To meet this requirement, Fabuwood has implemented a rigorous inspection process to assure that only first-class products, free of irregularities leave the plant.



PRO TOUCH TECHNIQUES

To fully permeate a Q12 assessment, expert finishing methods are required to heavily influence first impressions and assure a lasting finish that is easy to maintain. Fabuwood's own pro touch technique uses renowned brands to create a durable, simple to clean cabinet that will hold its beauty for years.

NO LIMITS

A STANDARD IS BORN

We thrive on a culture of innovation. Constantly ahead of the curve, Fabuwood is a place where creative ideas and ingenuity flourish.



DOVETAIL CONSTRUCTION

Another important facet of Q12 is the required use of dovetail construction. A process that involves plywood side panels to perfectly interlock with a solid wood face frame through corresponding dovetail grooves. This highly resilient technique that Fabuwood introduced to the market guarantees that Q12 cabinet lines are secure, strong, and long-lasting.



PRECISION IS A FINE LINE

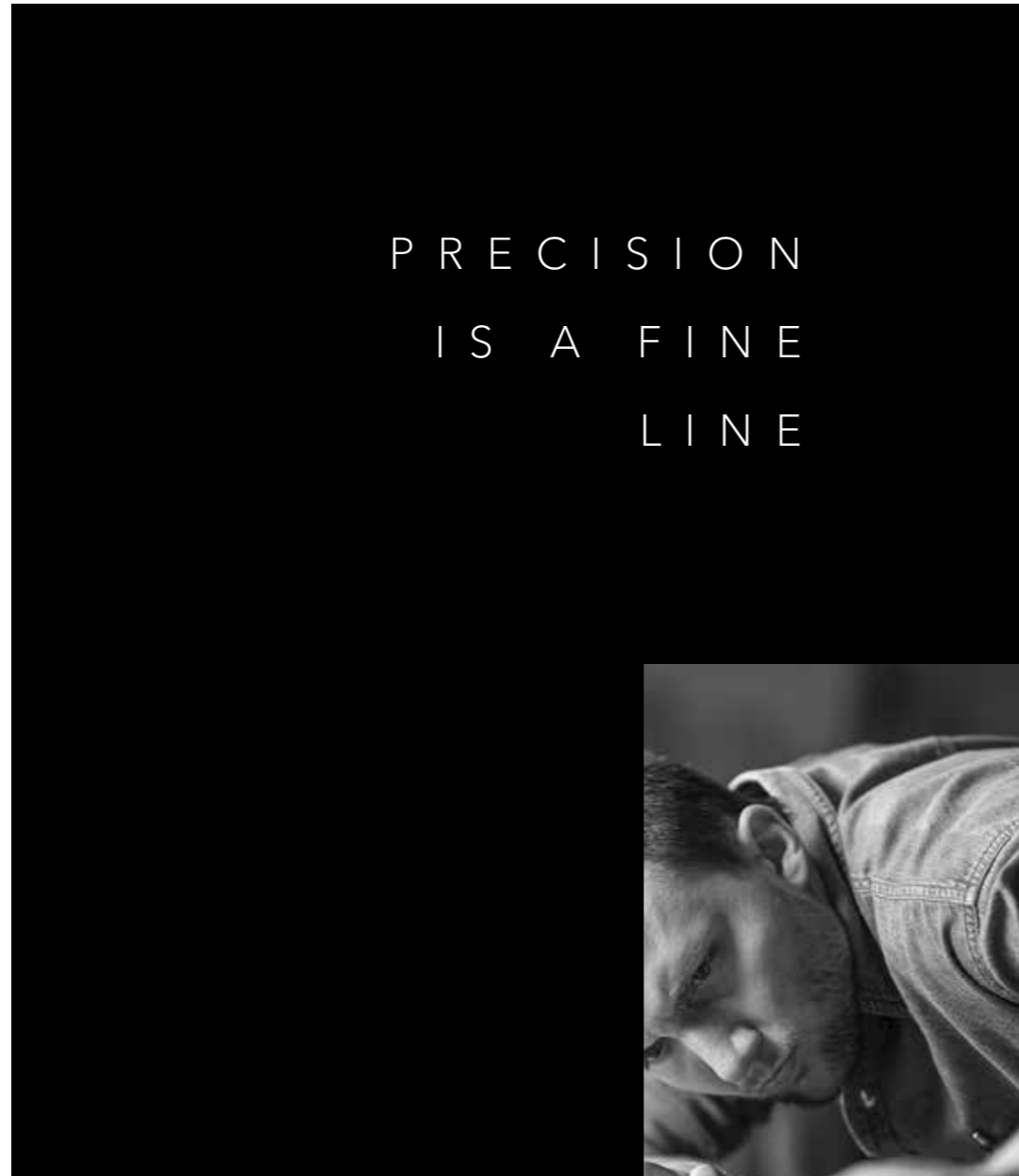

ANTI-WARP STRUCTURES

The anti-warp component involves the use of plywood panels comprised of rigid reinforcement beams. By applying the beams with a dovetail construction technique to secure all components, Fabuwood meets this standard ensuring a strong, reliable build that is resistant to distortion.

WOODEN CORNER BLOCKS

For a cabinet to receive complete Q12 entitlement, wood must be used to help maintain structural integrity. To ensure a unified and organic design build, Fabuwood manufactures robust cabinet lines with wooden corner blocks, which keep the purity of an all-wood cohesive construction.





SOLID BACK BUILDS

For superior structural longevity, this Q12 feature requires that the back of a cabinet is constructed from one piece of solid half-inch plywood. Fabuwood fulfills this standard by manufacturing cabinet backs with a strong and single piece of plywood to ensure durable strength and dimensional stability.



FLUSH FIT FRAMES

In order to be considered Q12 compliant, a cabinet must have flush inner frames that provide an attractive appearance while giving added dimension to the internal area. Fabuwood's Q12 lines display prime craftsmanship with their flat surface top and bottom interior planes that result in convenient and practical usage.





8

FINISHED INTERIORS

Treated and finished cabinet interiors are another significant feature of Q12 as they produce a clear statement of quality and attention to detail. As opposed to manufacturing with an applied lining, Fabuwood's vigorous top treatment techniques create a refined and durable design that is free of bubbling, peeling and chipping.



9

SOFT-CLOSING ACTION

Another great characteristic of the Q12 qualification is the use of compact hinges with built-in, soft-close mechanism. Fabuwood uses the smooth-running capability and soft closing action of Blum's tandem plus blumotion hinges, providing an impeccably gentle and fluid cabinet function.

FLUID FULL-EXTENSION

Cabinets built with smooth full-extension glides guarantee an enhanced running action that maximizes storage to its full capacity and ensures Q12 eligibility. Fabuwood manufactures Q12 cabinets with Blum's tandem plus runners and soft-closing technology, precisely utilizing space while also preventing damage and depreciation.



10

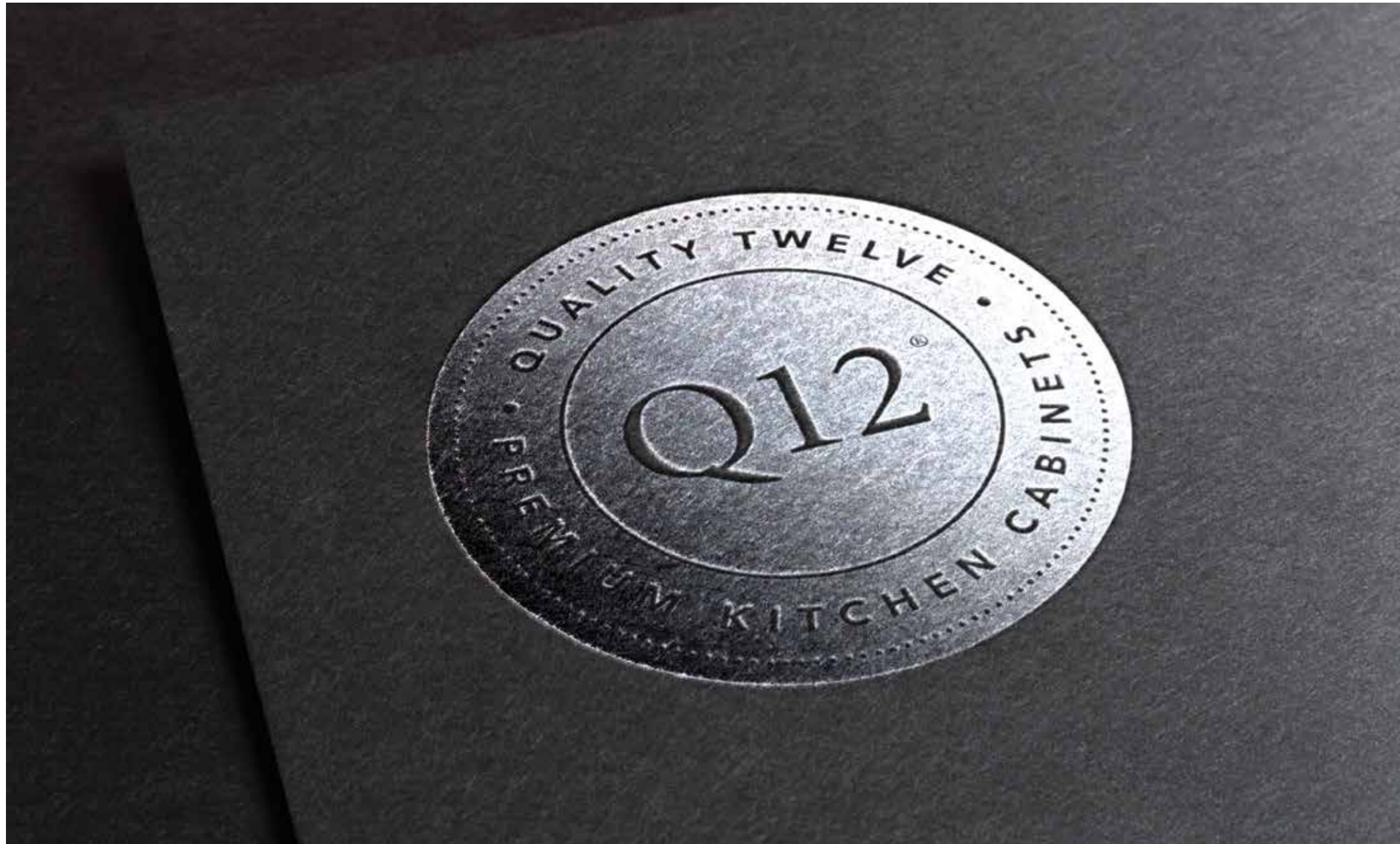

EZ LEVEL DRAWER FRONTS

To ensure proper door alignment and function, a Q12 cabinet requires an effortless system utilizing a degree of mechanical precision for installing perfectly positioned drawer faces. Fabuwood innovates with a unique technique using circular discs that allow for easy 3/8" adjustments in any direction, resulting in a Q12 cabinet that achieves an aesthetically graceful balance.



SEALED SIGNATURE

The final Q12 metric requires a thorough review at each manufacturing stage to ensure the completed product meets the provisions specified in the quality assurance system. Upon factory exit, a stamp of approval is given to show Fabuwood's commitment to quality control from the very first level of Q1 to the final Q12 stage, thus guaranteeing a superior and immaculate end product.

Allure

The sleek and stylish Allure collection establishes a transitional kitchen and is available in a variety of different styles and colors to attract an extensive array of homeowners.

D O O R S T Y L E S

Onyx / Galaxy / Fusion / Nexus

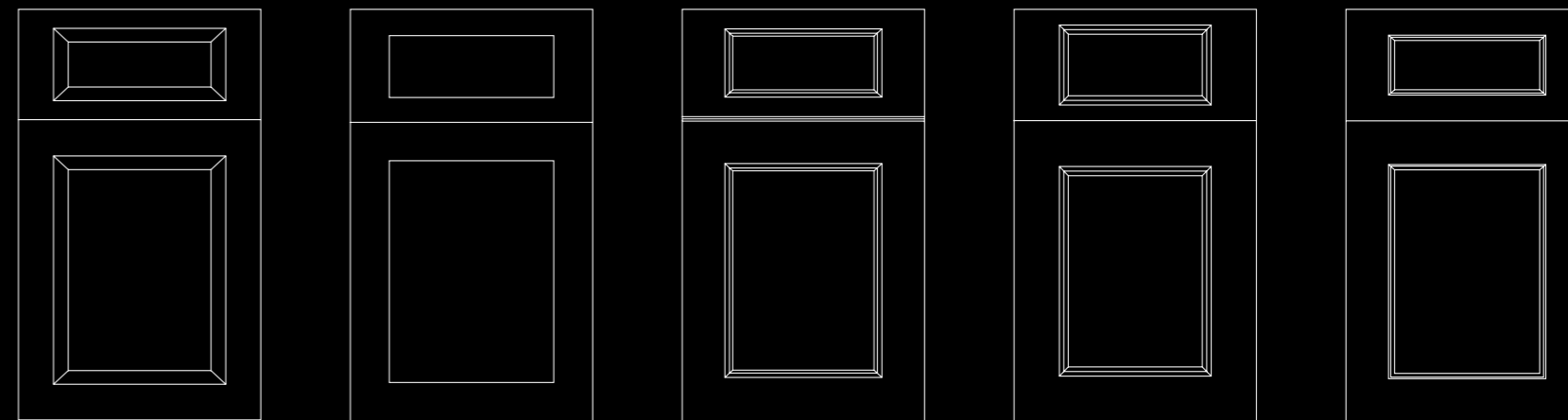

O N Y X



COBBLESTONE



HORIZON



FROST

The Onyx is sure to enhance the kitchen's design radiating a classy and transitional setting. This door offers an adaptable option that adds originality and interest to any kitchen and will look equally stylish in modern or classic spaces.



GALAXY

With smooth finishes, the galaxy line makes quite the impression creating a polished look with a modern flair. The line offers an impressive minimalistic masterpiece with enduring appeal.



ESPRESSO



PECAN



LINEN



FROST



NICKEL



COBBLESTONE

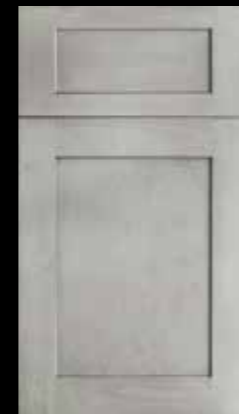

HORIZON





Play it smart. From classic to contemporary, the galaxy cabinets offer multiple selections to compliment today's 21st century tastes. This profile offers a wide variety of colors to help make your decorating choices unique and stylish all while maintaining function and durability. Compliment your urban lifestyle with cabinets that look as good as they wear.

FUSION



BLANC



CHESTNUT

The transitional fusion line stands out with its wide rail moldings, distinctive detailing and classic profiling. This detailed style gives your kitchen a touch of traditional splendor with a refreshing twist.





NEXUS



SLATE



FROST

A graceful wide frame creates a balance of conventional, yet contemporary appeal. The nexus collection showcases recessed paneling and is characterized by crisp clean lines. Use this style to add depth and sophistication to your aesthetic.



Classic

The name of this collection says it all. With two unique lines, the classic collection is timeless.



Wellington

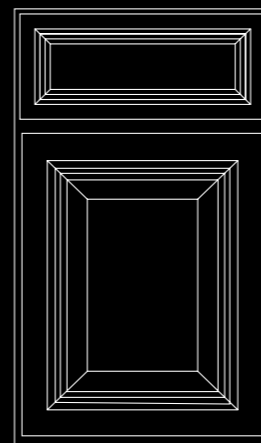



WELLINGTON



CINNAMON



IVORY

Choose Wellington and design a home that captures a warm familiarity with its elaborate woodwork. Featuring raised panels and applied moldings these cabinets create an intimate vibe in your living space. Recessed panel drawer fronts and a smooth glazed finish evoke an enduring traditional atmosphere.



Value

The value collection is your best option for affordable quality cabinetry that will stand the test of time.

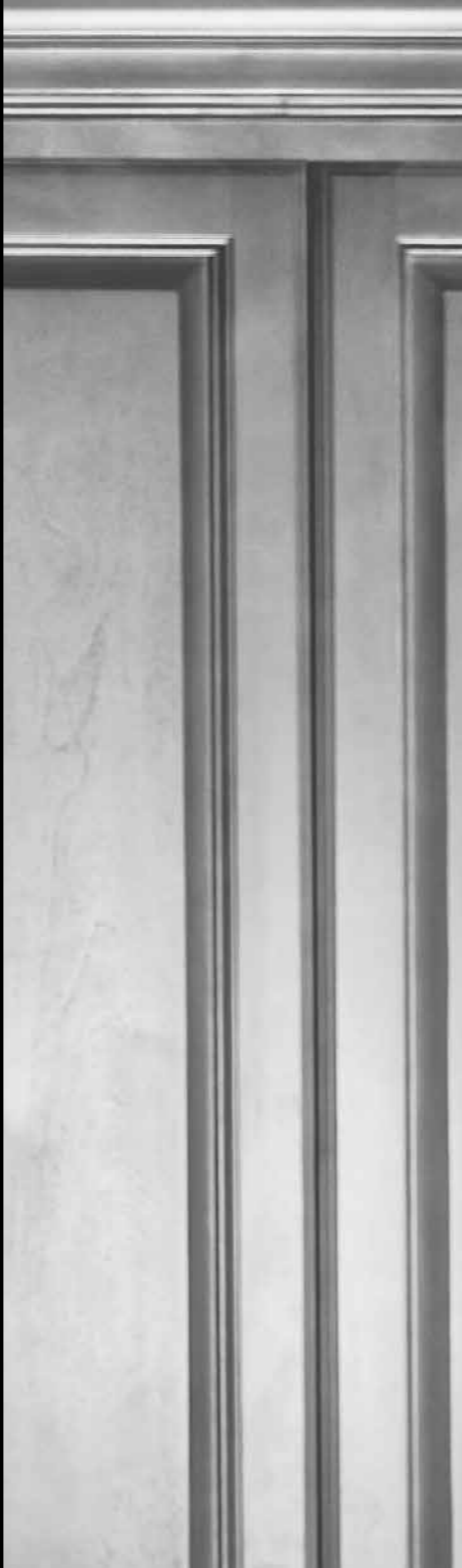

Hallmark

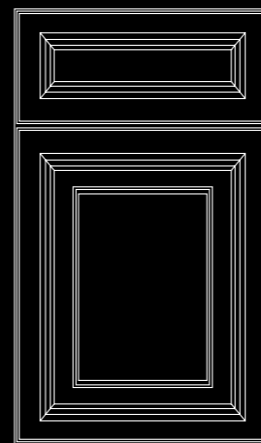

HALLMARK



CHESTNUT



BRANDY



PECAN



FROST

* Value Premium

The hallmark line blends top quality with refined style to represent true craftsmanship and tradition at an affordable price. With a distinctive artisan charm, these cabinets are sure to be a commanding focal point in any home with a classic setting. The beauty of the hallmark cabinet lies in its subtle traditional allure providing a warm and inviting sense of character to your kitchen.





ADA options

The key to a welcome home is warmth and functionality. At Fabuwood, we help Americans feel at home with our ADA compliant line of kitchens. We don't sacrifice form for function, rather, our numerous ADA options elegantly fulfill your everyday needs by creating customized, functional and affordable kitchens. Fabuwood's ADA options are available in select styles within our Allure and Value lines, eliminating the need for expensive customization. Whatever you're looking for, we have a kitchen that's right for you.

ADA OPTIONS ARE AVAILABLE
IN SELECT FABUWOOD LINES:



GALAXY
ESPRESSO



HALLMARK
PECAN



DISCOVERY
FROST



LANDMARK
BRANDY



LANDMARK
NATURAL

SINK BASE -
REMOVABLE FRONT

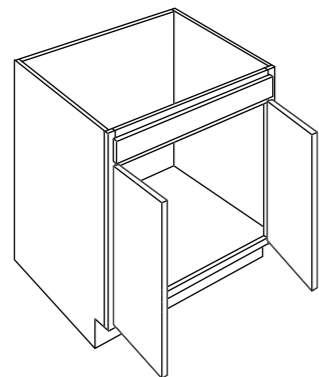

ADA-SB30
ADA-SB36

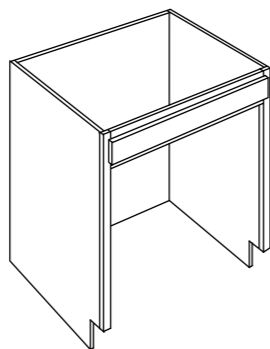

*After Doors, Floor &
Toe Kick are removed*

VANITY SINK BASE -
REMOVABLE FRONT

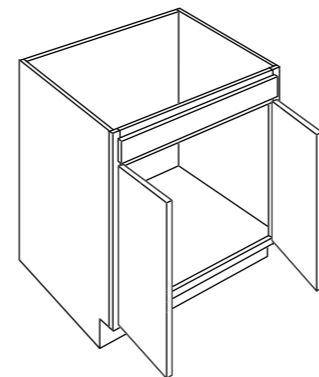

ADA-VSB30
ADA-VSB36

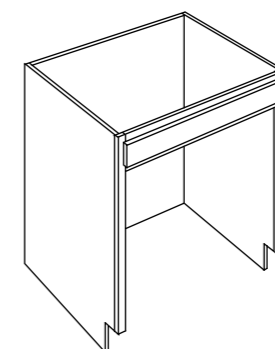

*After Doors, Floor &
Toe Kick are removed*

DRAWER
BASE

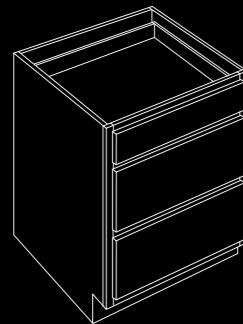

ADA-DB15
ADA-DB24

SINGLE
DOOR BASE

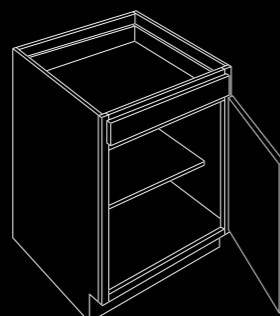

ADA-B12
ADA-B15
ADA-B18

DRAWER
BASE

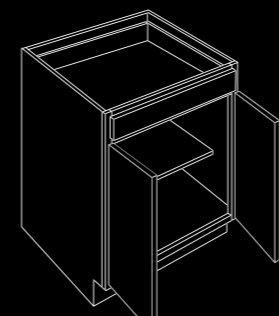

ADA-B24
ADA-B30

DOUBLE DOOR &
DRAWER BASE

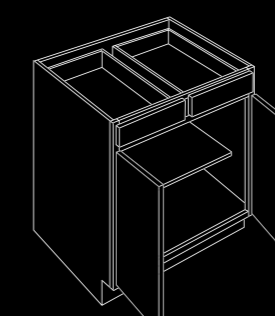

ADA-B36

VANITY
DRAWER
BASE

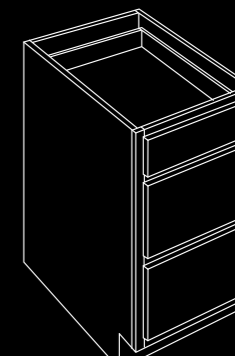

ADA-VDB15

CONTACT US FOR MORE INFO

sales@walcraftcabinetry.com

(888) 547-5573



256 Buena Vista St. Ste. 200 | Grass Valley, CA 95945 | T (888) 547-5573 | www.walcraftcabinetry.com

